

# LP3995

## Micropower 150mA CMOS Voltage Regulator with Active Shutdown

### General Description

The LP3995 linear regulator is designed to meet the requirements of portable battery-powered applications and will provide an accurate output voltage with low noise and low quiescent current. Ideally suited for powering RF/Analog devices, this device will also be used to meet more general circuit needs in which a fast turn-off is essential.

For battery powered applications the low dropout and low ground current provided by the device allows the lifetime of the battery to be maximized. The Enable/(Disable) control allows the system to further extend the battery lifetime by reducing the power consumption to virtually zero.

The Enable/(Disable) function on the device incorporates an active discharge circuit on the output for faster device shutdown. Where the fast turn-off is not required the LP3999 linear regulator is recommended.

The LP3995 also features internal protection against short-circuit currents and over-temperature conditions.

The LP3995 is designed to be stable with small 1.0  $\mu\text{F}$  ceramic capacitors. The small outline of the LP3995 micro SMD package with the required ceramic capacitors can realize a system application within minimal board area.

Performance is specified for a  $-40^{\circ}\text{C}$  to  $+125^{\circ}\text{C}$  temperature range.

The device is available in micro SMD package and LLP package. For other package options contact your local NSC sales office.

The device is available in fixed output voltages in the ranges 1.5V to 3.3V. For availability, please contact your local NSC sales office.

### Key Specifications

- 2.5V to 6.0V Input Range
- Accurate Output Voltage;  $\pm 75\text{mV} / 2\%$
- 60 mV Typical Dropout with 150 mA Load
- Virtually Zero Quiescent Current when Disabled
- Low Output Voltage Noise
- Stable with a 1  $\mu\text{F}$  Output Capacitor
- Guaranteed 150 mA Output Current
- Fast Turn-on; 30  $\mu\text{s}$  (Typ.)
- Fast Turn-off; 175  $\mu\text{s}$  (Typ.)

### Features

- 5 pin micro SMD Package
- 6 pin LLP Package
- Stable with Ceramic Capacitor
- Logic Controlled Enable
- Fast Turn-on
- Active Disable for Fast Turn-off.
- Thermal-overload and Short-circuit Protection
- $-40$  to  $+125^{\circ}\text{C}$  Junction Temperature Range for Operation

### Applications

- GSM Portable Phones
- CDMA Cellular Handsets
- Wideband CDMA Cellular Handsets
- Bluetooth Devices
- Portable Information Appliances

### Typical Application Circuit

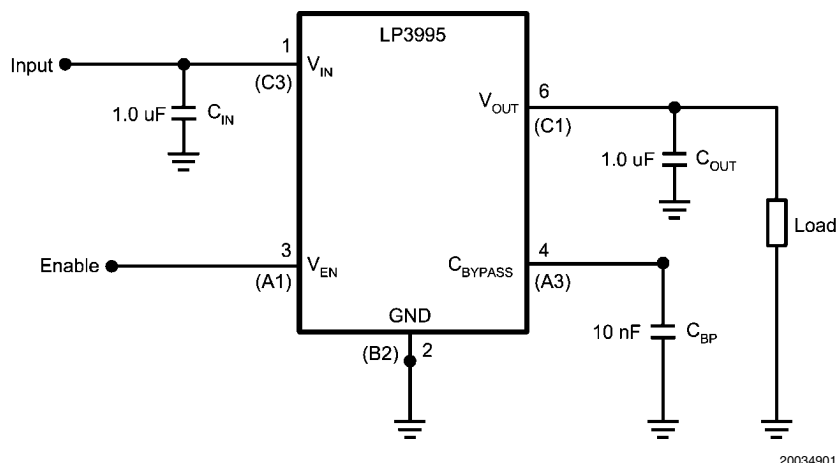

## Block Diagram

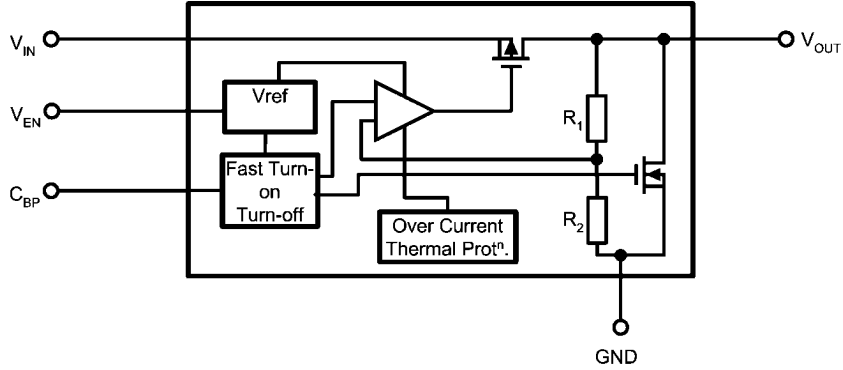

20034902

## Pin Descriptions

### 5 Pin micro SMD and LLP - 6

Pin No.		Symbol	Name and Function
micro SMD	LLP		
A1	3	$V_{EN}$	Enable Input; Disables the Regulator when $\leq 0.4V$ . Enables the regulator when $\geq 0.9V$
B2	2	GND	Common Ground
C1	6	$V_{OUT}$	Voltage output. Connect this output to the load circuit.
C3	1	$V_{IN}$	Voltage Supply Input
A3	4	$C_{BYPASS}$	Bypass Capacitor connection. Connect a $0.01 \mu F$ capacitor for noise reduction.
	5	N/C	No internal connection. There should not be any board connection to this pin.
	Pad	GND	Ground connection. Connect to ground plane for best thermal conduction.

## Connection Diagrams

### micro SMD, 5 Bump Package

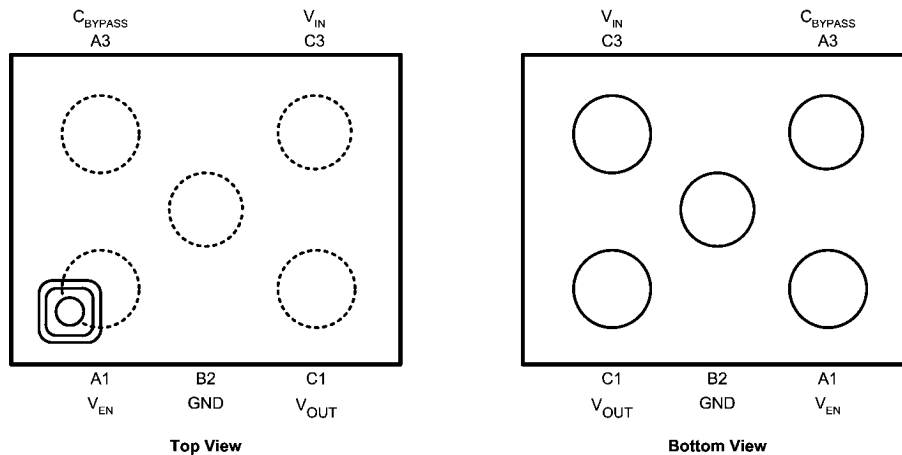

Top View  
See NS Package Number TLA05

20034903

LLP- 6 Package (SOT23 Footprint)

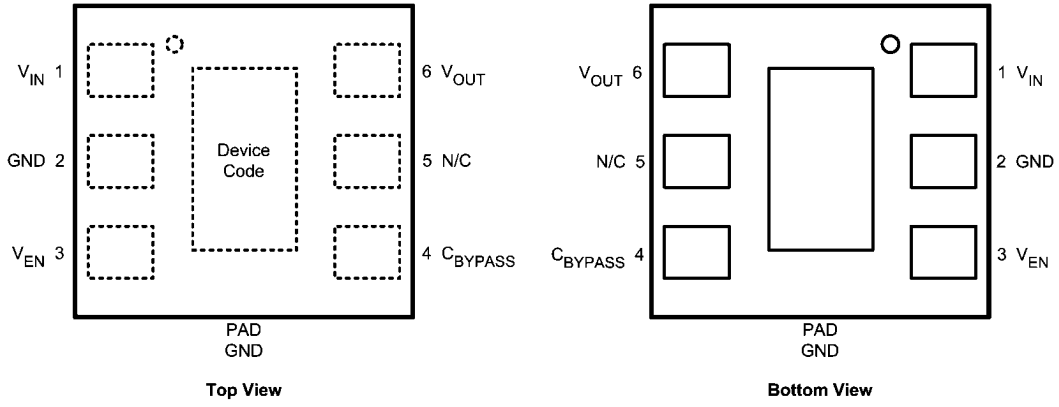

Top View  
See NS Package Number LDE06A

20034904

## Ordering Information

### For micro SMD Package

Output Voltage (V)	Grade	LP3995 Supplied as 250 Units, Tape and Reel	LP3995 Supplied as 3000 Units, Tape and Reel	Package Marking
1.5 (Note 2)	STD	LP3995ITL-1.5	LP3995ITLX-1.5	XV I9
1.6 (Note 2)	STD	LP3995ITL-1.6	LP3995ITLX-1.6	XV I9
1.8 (Note 2)	STD	LP3995ITL-1.8	LP3995ITLX-1.8	XV I9
1.9 (Note 2)	STD	LP3995ITL-1.9	LP3995ITLX-1.9	XV I9
2.1 (Note 2)	STD	LP3995ITL-2.1	LP3995ITLX-2.1	XV I9
2.5 (Note 2)	STD	LP3995ITL-2.5	LP3995ITLX-2.5	XV I9
2.8 (Note 2)	STD	LP3995ITL-2.8	LP3995ITLX-2.8	XV I9
2.85 (Note 2)	STD	LP3995ITL-2.85	LP3995ITLX-2.85	XV I9
3.0 (Note 2)	STD	LP3995ITL-3.0	LP3995ITLX-3.0	XV I9

### For micro SMD Package (Lead Free)

Output Voltage (V)	Grade	LP3995 Supplied as 250 Units, Tape and Reel	LP3995 Supplied as 3000 Units, Tape and Reel	Package Marking
1.5	STD	LP3995ITL-1.5/NOPB	LP3995ITLX-1.5/NOPB	XV I9
1.6	STD	LP3995ITL-1.6/NOPB	LP3995ITLX-1.6/NOPB	XV I9
1.8	STD	LP3995ITL-1.8/NOPB	LP3995ITLX-1.8/NOPB	XV I9
1.9	STD	LP3995ITL-1.9/NOPB	LP3995ITLX-1.9/NOPB	XV I9
2.1	STD	LP3995ITL-2.1/NOPB	LP3995ITLX-2.1/NOPB	XV I9
2.5	STD	LP3995ITL-2.5/NOPB	LP3995ITLX-2.5/NOPB	XV I9
2.7	STD	LP3995ITL-2.7/NOPB	LP3995ITLX-2.7/NOPB	XV I9
2.8	STD	LP3995ITL-2.8/NOPB	LP3995ITLX-2.8/NOPB	XV I9
2.85	STD	LP3995ITL-2.85/NOPB	LP3995ITLX-2.85/NOPB	XV I9
3.0	STD	LP3995ITL-3.0/NOPB	LP3995ITLX-3.0/NOPB	XV I9

### For LLP- 6 Package

Output Voltage (V)	Grade	LP3995 Supplied as 1000 Units, Tape and Reel	LP3995 Supplied as 4500 Units, Tape and Reel	Package Marking
1.5	STD	LP3995ILD-1.5	LP3995ILD-1.5	LO20B
1.6	STD	LP3995ILD-1.6	LP3995ILD-1.6	LO21B
1.8	STD	LP3995ILD-1.8	LP3995ILD-1.8	LO22B
2.8	STD	LP3995ILD-2.8	LP3995ILD-2.8	LO26B
3.0	STD	LP3995ILD-3.0	LP3995ILD-3.0	LO30B

**Note 1:** Available in sample quantities only

**Note 2:** For availability contact your local sales office

## Absolute Maximum Ratings

(Notes 3, 4)

If Military/Aerospace specified devices are required, please contact the National Semiconductor Sales Office/Distributors for availability and specifications.

Input Voltage ( $V_{IN}$ )	-0.3 to 6.5V
Output Voltage	-0.3 to ( $V_{IN} + 0.3V$ ) to 6.5V (max)
Enable Input Voltage	-0.3 to 6.5V
Junction Temperature	150°C
Lead/Pad Temperature (Note 5)	
micro SMD	260°C
LLP	235°C
Storage Temperature	-65 to +150°C
Continuous Power Dissipation Internally Limited (Note 7)	
ESD (Note 9)	
Human Body Model	2 kV
Machine Model	200V

## Operating Ratings (Note 3)

Input Voltage ( $V_{IN}$ )	2.5 to 6.0V
Enable Input Voltage	0 to 6.0V
Junction Temperature	-40 to +125°C
Ambient Temperature Range (Note 7)	-40 to 85°C

## Thermal Properties (Note 8)

Junction to Ambient Thermal Resistance	
$\theta_{JA}$ (LLP pkg.)	88°C/W
$\theta_{JA}$ (micro SMD pkg.)	255°C/W

## Electrical Characteristics

Unless otherwise noted,  $V_{EN} = 1.5$ ,  $V_{IN} = V_{OUT} + 1.0V$ ,  $C_{IN} = 1 \mu F$ ,  $I_{OUT} = 1$  mA,  $C_{OUT} = 1 \mu F$ ,  $c_{BP} = 0.01 \mu F$ . Typical values and limits appearing in normal type apply for  $T_J = 25^\circ C$ . Limits appearing in **boldface** type apply over the full temperature range for operation, -40 to +125°C. (Notes 14, 15)

Symbol	Parameter	Conditions	Typical	Limit		Units
				Min	Max	
$V_{IN}$	Input Voltage			2.5	6.0	V
<b>DEVICE OUTPUT: <math>1.5 \leq V_{OUT} &lt; 1.8V</math></b>						
$\Delta V_{OUT}$	Output Voltage Tolerance	$I_{OUT} = 1$ mA		-50	50	mV
				<b>-75</b>	<b>75</b>	
	Line Regulation Error	$V_{IN} = (V_{OUT(NOM)} + 1.0V)$ to 6.0V, $I_{OUT} = 1$ mA		<b>-3.5</b>	<b>3.5</b>	mV/V
	<b>micro SMD</b> Load Regulation Error	$I_{OUT} = 1$ mA to 150 mA	10		<b>75</b>	$\mu V/mA$
	<b>LLP</b> Load Regulation Error	$I_{OUT} = 1$ mA to 150 mA	70		<b>125</b>	$\mu V/mA$
PSRR	Power Supply Rejection Ratio (Note 11)	$f = 1$ kHz, $I_{OUT} = 1$ mA	55			dB
		$f = 10$ kHz, $I_{OUT} = 1$ mA	53			
<b>DEVICE OUTPUT: <math>1.8 \leq V_{OUT} &lt; 2.5V</math></b>						
$\Delta V_{OUT}$	Output Voltage Tolerance	$I_{OUT} = 1$ mA		-50	50	mV
				<b>-75</b>	<b>75</b>	
	<b>microSMD</b> Line Regulation Error	$V_{IN} = (V_{OUT(NOM)} + 1.0V)$ to 6.0V, $I_{OUT} = 1$ mA		<b>-2.5</b>	<b>2.5</b>	mV/V
	<b>LLP</b> Line Regulation Error	$V_{IN} = (V_{OUT(NOM)} + 1.0V)$ to 6.0V, $I_{OUT} = 1$ mA		<b>-3.5</b>	<b>3.5</b>	mV/V
	<b>micro SMD</b> Load Regulation Error	$I_{OUT} = 1$ mA to 150 mA	10		<b>75</b>	$\mu V/mA$
	<b>LLP</b> Load Regulation Error	$I_{OUT} = 1$ mA to 150 mA	80		<b>125</b>	$\mu V/mA$
PSRR	Power Supply Rejection Ratio (Note 11)	$f = 1$ kHz, $I_{OUT} = 1$ mA	55			dB
		$f = 10$ kHz, $I_{OUT} = 1$ mA	50			

Symbol	Parameter	Conditions	Typical	Limit		Units
				Min	Max	
<b>DEVICE OUTPUT: <math>2.5 \leq V_{OUT} \leq 3.3V</math></b>						
$\Delta V_{OUT}$	Output Voltage Tolerance	$I_{OUT} = 1 \text{ mA}$		-2	2	% of $V_{OUT}$ (NOM)
	Line Regulation Error	$V_{IN} = (V_{OUT(NOM)} + 1.0V)$ to 6.0V, $I_{OUT} = 1 \text{ mA}$		-0.1	0.1	%/V
	<b>micro SMD</b> Load Regulation Error	$I_{OUT} = 1 \text{ mA}$ to 150 mA	0.0004		0.002	%/mA
	<b>LLP</b> Load Regulation Error	$I_{OUT} = 1 \text{ mA}$ to 150 mA	0.002		0.005	%/mA
	Dropout Voltage		$I_{OUT} = 1 \text{ mA}$	0.4		2
$I_{OUT} = 150 \text{ mA}$			60		100	
PSRR	Power Supply Rejection Ratio (Note 11)	$f = 1 \text{ kHz}$ , $I_{OUT} = 1 \text{ mA}$	60			dB
		$f = 10 \text{ kHz}$ , $I_{OUT} = 1 \text{ mA}$	50			
<b>FULL <math>V_{OUT}</math> RANGE</b>						
$I_{LOAD}$	Load Current	(Notes 10, 11)		0		$\mu\text{A}$
$I_Q$	Quiescent Current	$V_{EN} = 1.5V$ , $I_{OUT} = 0 \text{ mA}$	85		150	$\mu\text{A}$
		$V_{EN} = 1.5V$ , $I_{OUT} = 150 \text{ mA}$	140		200	
		$V_{EN} = 0.4V$	0.003		1.5	
$I_{SC}$	Short Circuit Current Limit		450			mA
$E_N$	Output Noise Voltage ((Note 11))	BW = 10 Hz to 100 kHz, $V_{IN} = 4.2V$ , $I_{OUT} = 1 \text{ mA}$	25			$\mu\text{Vrms}$
$T_{SHUTDOWN}$	Thermal Shutdown	Temperature	160			$^{\circ}\text{C}$
		Hysteresis	20			
<b>ENABLE CONTROL CHARACTERISTICS</b>						
$I_{EN}$	Maximum Input Current at $V_{EN}$ Input	$V_{EN} = 0.0V$ and $V_{IN} = 6.0V$	0.001			$\mu\text{A}$
$V_{IL}$	Low Input Threshold				0.4	V
$V_{IH}$	High Input Threshold			0.9		V
<b>TIMING CHARACTERISTICS</b>						
$T_{ON}$	Turn On Time (Note 11)	To 95% Level (Note 12)	30			$\mu\text{s}$
$T_{OFF}$	Turn Off Time (Note 11)	To 5% Level (Note 13)	175			$\mu\text{s}$

**Note 3:** Absolute Maximum Ratings are limits beyond which damage to the device may occur. Operating Ratings are conditions under which operation of the device is guaranteed. Operating Ratings do not imply guaranteed performance limits. For guaranteed performance limits and associated test conditions, see the Electrical Characteristics tables.

**Note 4:** All voltages are with respect to the potential at the GND pin.

**Note 5:** For information regarding micro SMD and LLP packages please refer to the following application notes;

AN-1112 Micro SMD Package Wafer Level Chip Scale Package,

AN-1187. Leadless Leadframe Package.

**Note 6:** Internal Thermal shutdown circuitry protects the device from permanent damage.

**Note 7:** In applications where high power dissipation and/or poor thermal resistance is present, the maximum ambient temperature may have to be derated. Maximum ambient temperature ( $T_{A(max)}$ ) is dependant on the maximum operating junction temperature ( $T_{J(max-op)}$ ), the maximum power dissipation ( $P_{D(max)}$ ), and the junction to ambient thermal resistance in the application ( $\theta_{JA}$ ). This relationship is given by :-

$$T_{A(max)} = T_{J(max-op)} - (P_{D(max)} \times \theta_{JA})$$

**Note 8:** Junction to ambient thermal resistance is highly dependant on the application and board layout. In applications where high thermal dissipation is possible, special care must be paid to thermal issues in the board design.

**Note 9:** The human body model is an 100 pF discharge through a 1.5 k $\Omega$  resistor into each pin. The machine model is a 200 pF capacitor discharged directly into each pin.

**Note 10:** The device maintains a stable, regulated output voltage without load.

**Note 11:** This electrical specification is guaranteed by design.

**Note 12:** Time from  $V_{EN} = 0.9V$  to  $V_{OUT} = 95\%$  ( $V_{OUT(NOM)}$ )

**Note 13:** Time from  $V_{EN} = 0.4V$  to  $V_{OUT} = 5\%$  ( $V_{OUT(NOM)}$ )

**Note 14:** All limits are guaranteed. All electrical characteristics having room-temperature limits are tested during production at  $T_j = 25^\circ\text{C}$  or correlated using Statistical Quality Control methods. Operation over the temperature specification is guaranteed by correlating the electrical characteristics to process and temperature variations and applying statistical process control.

**Note 15:**  $V_{\text{OUT(NOM)}}$  is the stated output voltage option for the device.

## Recommended Output Capacitor

Symbol	Parameter	Conditions	VALUE	Limit		Units
				Min	Max	
$C_{\text{OUT}}$	Output Capacitor	Capacitance (Note 16)	1.0	0.70		$\mu\text{F}$
		ESR		5	500	$\text{m}\Omega$

**Note 16:** The capacitor tolerance should be  $\pm 30\%$  or better over the temperature range. The recommended capacitor type is X7R however, dependant on the application X5R, Y5V, and Z5U can also be used.

## Input Test Signals

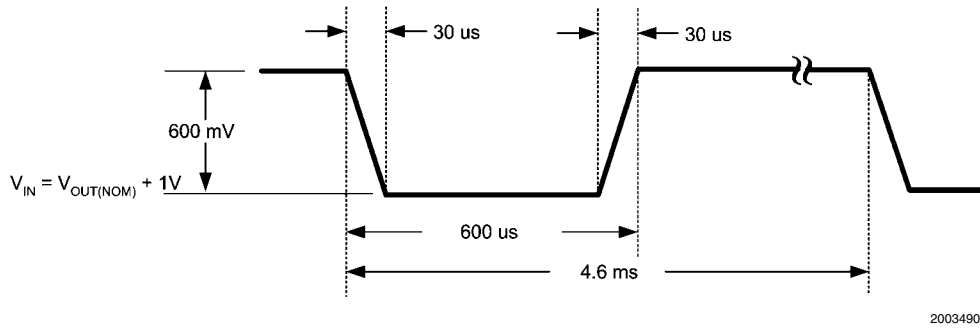

**FIGURE 1. Line Transient Response Input Test Signal**

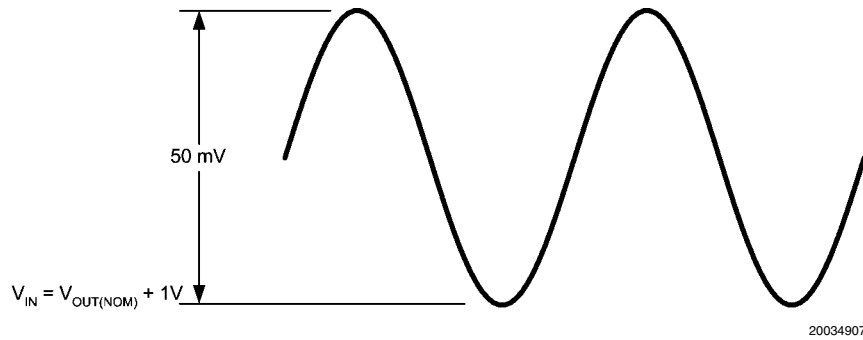

**FIGURE 2. PSRR Input Test Signal**

# Typical Performance Characteristics

$V_{OUT} + 1.0V$ ,  $T_A = 25^\circ C$ , Enable pin is tied to  $V_{IN}$ .

Unless otherwise specified,  $C_{IN} = C_{OUT} = 1.0 \mu F$  Ceramic,  $V_{IN} =$

**Output Voltage Change vs Temperature**

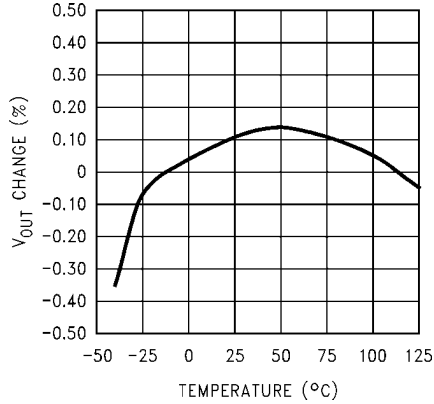

20034910

**Ground Current vs Load Current (1.8V  $V_{OUT}$ )**

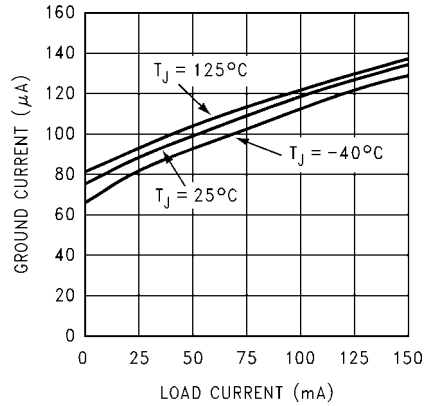

20034911

**Ground Current vs Load Current (2.8V  $V_{OUT}$ )**

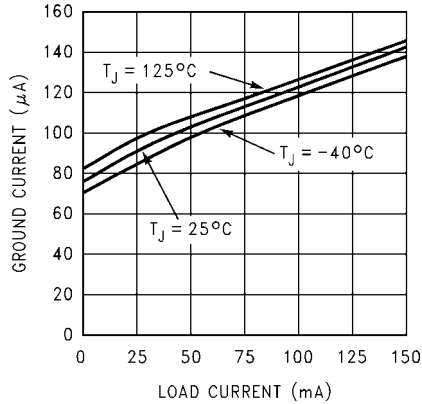

20034912

**Ground Current vs  $V_{IN}$  @ 25°C**

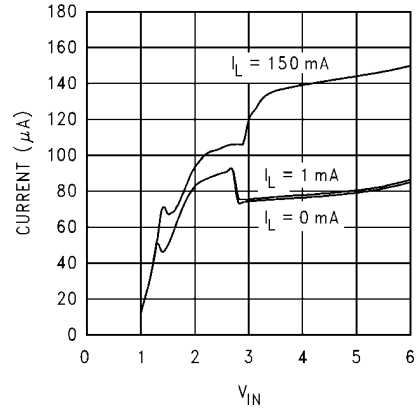

20034913

**Ground Current vs  $V_{IN}$  @ 125°C**

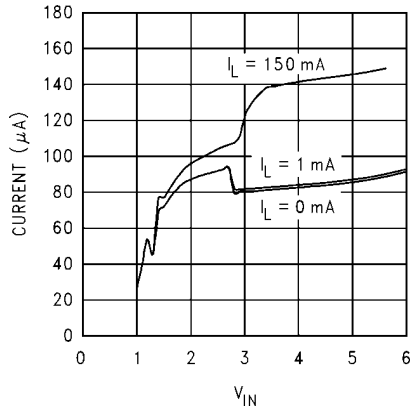

20034914

**Dropout vs Load Current**

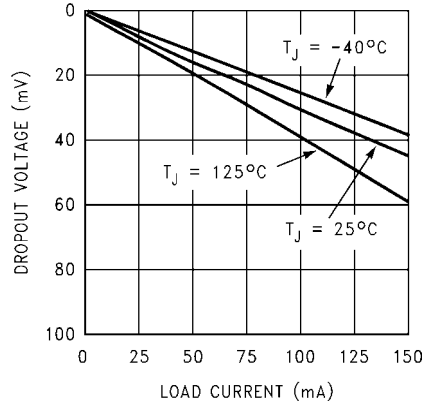

20034915



Short Circuit Current

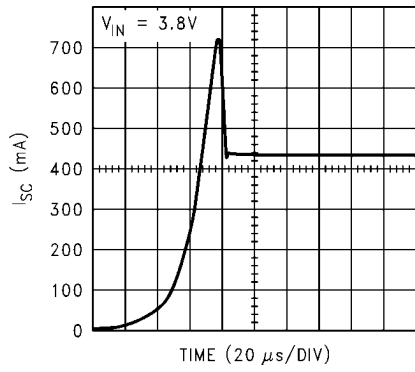

20034916

Line Transient Response ( $V_{OUT} = 2.8V$ )

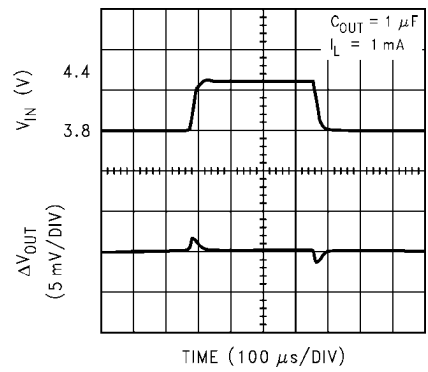

20034917

Ripple Rejection ( $V_{OUT} = 1.8V$ )

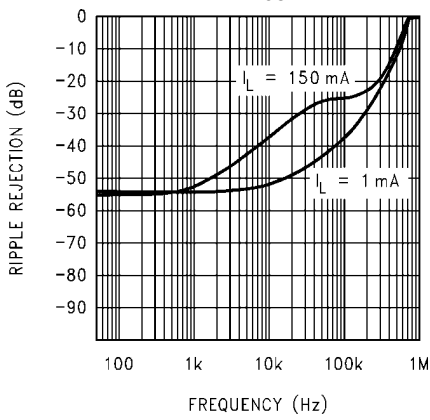

20034918

Ripple Rejection ( $V_{OUT} = 2.8V$ )

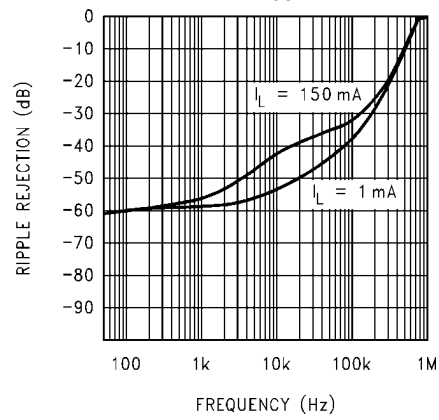

20034919

Enable Start-Up Time ( $V_{OUT} = 2.8V$ )

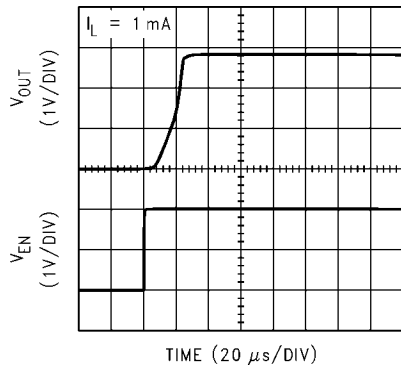

20034920

Enable Start-Up Time ( $V_{OUT} = 2.8V$ )

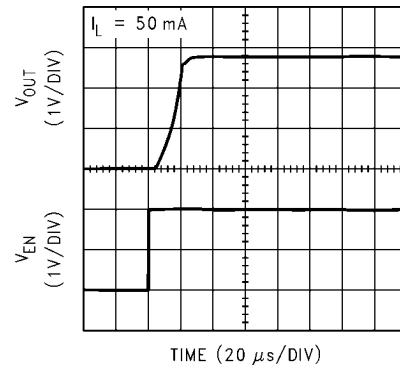

20034921

Enable Start-Up Time ( $V_{OUT} = 1.8V$ )

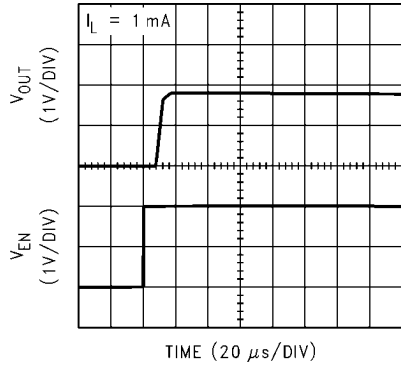

20034922

Enable Start-Up Time ( $V_{OUT} = 1.8V$ )

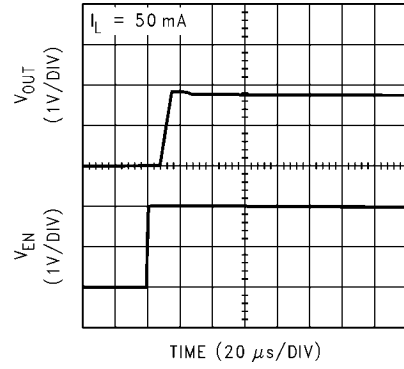

20034923

Turn-Off Time ( $V_{OUT} = 2.8V$ )

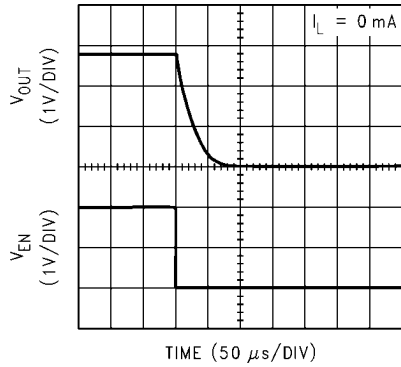

20034924

Turn-Off Time ( $V_{OUT} = 1.8V$ )

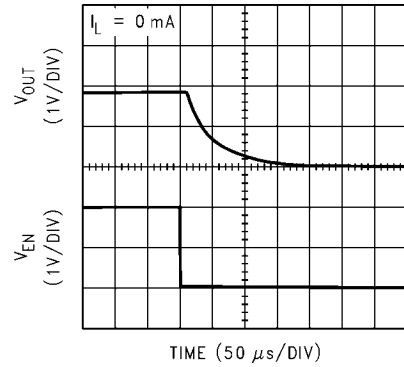

20034925

Load Transient Response ( $V_{OUT} = 2.8V$ )

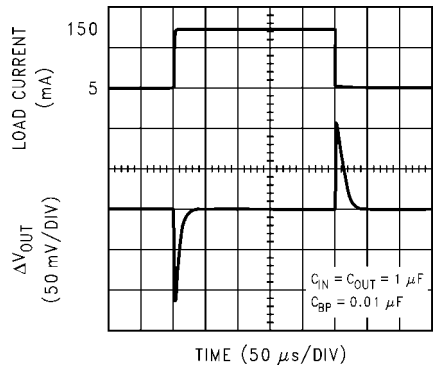

20034926

Load Transient Response ( $V_{OUT} = 1.8V$ )

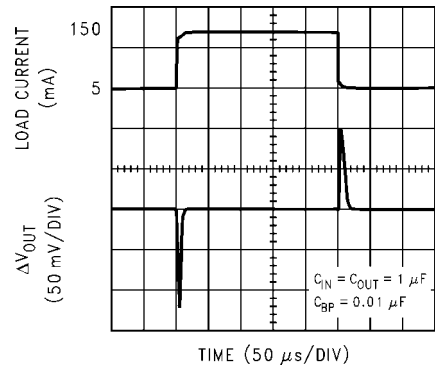

20034927

## Application Hints

### POWER DISSIPATION AND DEVICE OPERATION

The permissible power dissipation for any package is a measure of the capability of the device to pass heat from the power source, the junctions of the IC, to the ultimate heat sink, the ambient environment. Thus the power dissipation is dependent on the ambient temperature and the thermal resistance across the various interfaces between the die and ambient air.

The Thermal Resistance figure

Re-stating the equation in (Note 7) in the electrical specification section, the allowable power dissipation for the device in a given package can be calculated:

$$P_D = \frac{(T_{J(MAX)} - T_A)}{\theta_{JA}}$$

With a  $\theta_{JA} = 255^\circ\text{C/W}$ , the device in the micro SMD package returns a value of 392 mW with a maximum junction temperature of  $125^\circ\text{C}$ .

With a  $\theta_{JA} = 88^\circ\text{C/W}$ , the device in the LLP package returns a value of 1.136 mW with a maximum junction temperature of  $125^\circ\text{C}$ .

The actual power dissipation across the device can be represented by the following equation:

$$P_D = (V_{IN} - V_{OUT}) \times I_{OUT}$$

This establishes the relationship between the power dissipation allowed due to thermal consideration, the voltage drop across the device, and the continuous current capability of the device. These two equations should be used to determine the optimum operating conditions for the device in the application.

### EXTERNAL CAPACITORS

In common with most regulators, the LP3995 requires external capacitors to ensure stable operation. The LP3995 is specifically designed for portable applications requiring minimum board space and smallest components. These capacitors must be correctly selected for good performance.

### INPUT CAPACITOR

An input capacitor is required for stability. It is recommended that a  $1.0 \mu\text{F}$  capacitor be connected between the LP3995 input pin and ground (this capacitance value may be increased without limit).

This capacitor must be located a distance of not more than 1 cm from the input pin and returned to a clean analogue ground. Any good quality ceramic, tantalum, or film capacitor may be used at the input.

**Important:** Tantalum capacitors can suffer catastrophic failures due to surge current when connected to a low-impedance source of power (like a battery or a very large capacitor). If a tantalum capacitor is used at the input, it must be guaranteed by the manufacturer to have a surge current rating sufficient for the application.

There are no requirements for the **ESR** (Equivalent Series Resistance) on the input capacitor, but tolerance and temperature coefficient must be considered when selecting the capacitor to ensure the capacitance will remain  $\cong 1.0 \mu\text{F}$  over the entire operating temperature range.

### OUTPUT CAPACITOR

The LP3995 is designed specifically to work with very small ceramic output capacitors. A ceramic capacitor (dielectric

types Z5U, Y5V or X7R) in the  $1.0$  [to  $10 \mu\text{F}$ ] range, and with ESR between  $5 \text{ m}\Omega$  to  $500 \text{ m}\Omega$ , is suitable in the LP3995 application circuit.

For this device the output capacitor should be connected between the  $V_{OUT}$  pin and ground.

It may also be possible to use tantalum or film capacitors at the device output,  $V_{OUT}$ , but these are not as attractive for reasons of size and cost (see the section Capacitor Characteristics).

The output capacitor must meet the requirement for the minimum value of capacitance and also have an ESR value that is within the range  $5 \text{ m}\Omega$  to  $500 \text{ m}\Omega$  for stability.

### NO-LOAD STABILITY

The LP3995 will remain stable and in regulation with no external load. This is an important consideration in some circuits, for example CMOS RAM keep-alive applications.

### CAPACITOR CHARACTERISTICS

The LP3995 is designed to work with ceramic capacitors on the output to take advantage of the benefits they offer. For capacitance values in the range of  $1 \mu\text{F}$  to  $4.7 \mu\text{F}$ , ceramic capacitors are the smallest, least expensive and have the lowest ESR values, thus making them best for eliminating high frequency noise. The ESR of a typical  $1 \mu\text{F}$  ceramic capacitor is in the range of  $20 \text{ m}\Omega$  to  $40 \text{ m}\Omega$ , which easily meets the ESR requirement for stability for the LP3995.

The temperature performance of ceramic capacitors varies by type. Most large value ceramic capacitors ( $\geq 2.2 \mu\text{F}$ ) are manufactured with Z5U or Y5V temperature characteristics, which results in the capacitance dropping by more than 50% as the temperature goes from  $25^\circ\text{C}$  to  $85^\circ\text{C}$ .

A better choice for temperature coefficient in a ceramic capacitor is X7R. This type of capacitor is the most stable and holds the capacitance within  $\pm 15\%$  over the temperature range. Tantalum capacitors are less desirable than ceramic for use as output capacitors because they are more expensive when comparing equivalent capacitance and voltage ratings in the  $1 \mu\text{F}$  to  $4.7 \mu\text{F}$  range.

Another important consideration is that tantalum capacitors have higher ESR values than equivalent size ceramics. This means that while it may be possible to find a tantalum capacitor with an ESR value within the stable range, it would have to be larger in capacitance (which means bigger and more costly) than a ceramic capacitor with the same ESR value. It should also be noted that the ESR of a typical tantalum will increase about 2:1 as the temperature goes from  $25^\circ\text{C}$  down to  $-40^\circ\text{C}$ , so some guard band must be allowed.

### NOISE BYPASS CAPACITOR

A bypass capacitor should be connected between the  $C_{BP}$  pin and ground to significantly reduce the noise at the regulator output. This device pin connects directly to a high impedance node within the bandgap reference circuitry. Any significant loading on this node will cause a change on the regulated output voltage. For this reason, DC leakage current through this pin must be kept as low as possible for best output voltage accuracy.

The use of a  $0.01 \mu\text{F}$  bypass capacitor is strongly recommended to prevent overshoot on the output during start-up.

The types of capacitors best suited for the noise bypass capacitor are ceramic and film. High quality ceramic capacitors with NPO or COG dielectric typically have very low leakage. Polypropylene and polycarbonate film capacitors are available in small surface-mount packages and typically have extremely low leakage current.

Unlike many other LDO's, the addition of a noise reduction capacitor does not effect the transient response of the device.

#### **ENABLE OPERATION**

The LP3995 may be switched ON or OFF by a logic input at the ENABLE pin,  $V_{EN}$ . A high voltage at this pin will turn the device on. When the enable pin is low, the regulator output is off and the device typically consumes 3 nA. If the application does not require the shutdown feature, the  $V_{EN}$  pin should be tied to  $V_{IN}$  to keep the regulator output permanently on. To ensure proper operation, the signal source used to drive the  $V_{EN}$  input must be able to swing above and below the specified turn-on/off voltage thresholds listed in the Electrical Characteristics section under  $V_{IL}$  and  $V_{IH}$ .

#### **FAST TURN OFF AND ON**

The controlled switch-off feature of the device provides a fast turn off by discharging the output capacitor via an internal FET device. This discharge is current limited by the  $R_{DSon}$  of this switch. Fast turn-on is guaranteed by control circuitry within the reference block allowing a very fast ramp of the output voltage to reach the target voltage.

#### **micro SMD MOUNTING**

The micro SMD package requires specific mounting techniques which are detailed in National Semiconductor Application Note AN-1112.

Referring to the section *Surface Mount Technology (SMT) Assembly Considerations*, it should be noted that the pad style which must be used with the 5 pin package is NSMD (non-solder mask defined) type.

For best results during assembly, alignment ordinals on the PC board may be used to facilitate placement of the micro SMD device.

#### **micro SMD LIGHT SENSITIVITY**

Exposing the micro SMD device to direct sunlight will cause incorrect operation of the device. Light sources such as halogen lamps can affect electrical performance if they are situated in proximity to the device.

Light with wavelengths in the red and infra-red part of the spectrum have the most detrimental effect thus the fluorescent lighting used inside most buildings has very little effect on performance. Tests carried out on a micro SMD test board showed a negligible effect on the regulated output voltage when brought within 1 cm of a fluorescent lamp. A deviation of less than 0.1% from nominal output voltage was observed.

**Physical Dimensions** inches (millimeters) unless otherwise noted

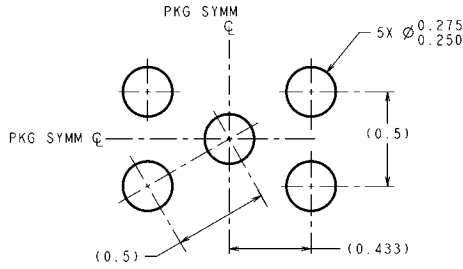

**DIMENSIONS ARE IN MILLIMETERS**  
 DIMENSIONS IN ( ) FOR REFERENCE ONLY

**LAND PATTERN RECOMMENDATION**

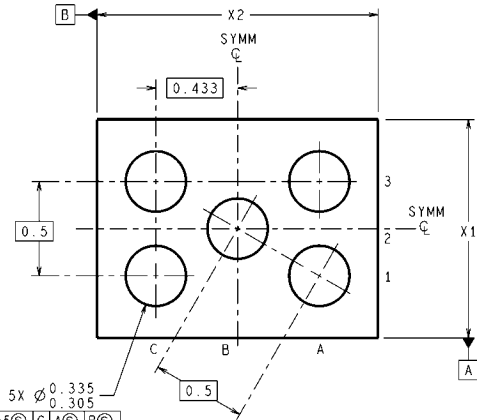
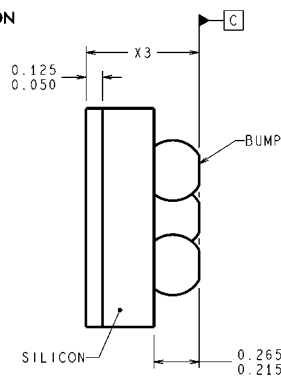
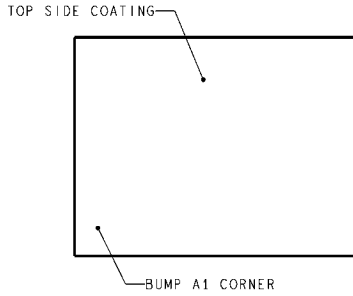

TLA05XXX (Rev C)

**micro SMD, 5 Bump, Package (TLA05)**  
**NS Package Number TLA05ADA**  
 The dimensions for X1, X2 and X3 are given as:  
**X1 = 1.006 +/- 0.03mm**  
**X2 = 1.438 +/- 0.03mm**  
**X3 = 0.600 +/- 0.075mm**

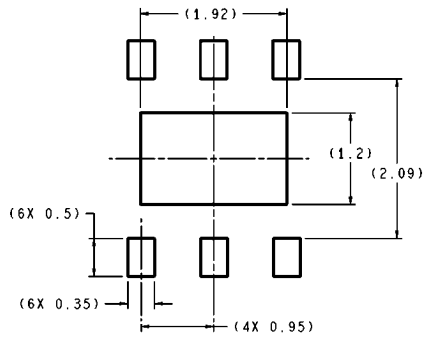

RECOMMENDED LAND PATTERN  
1:1 RATIO WITH PKG SOLDER PADS

DIMENSIONS ARE IN MILLIMETERS

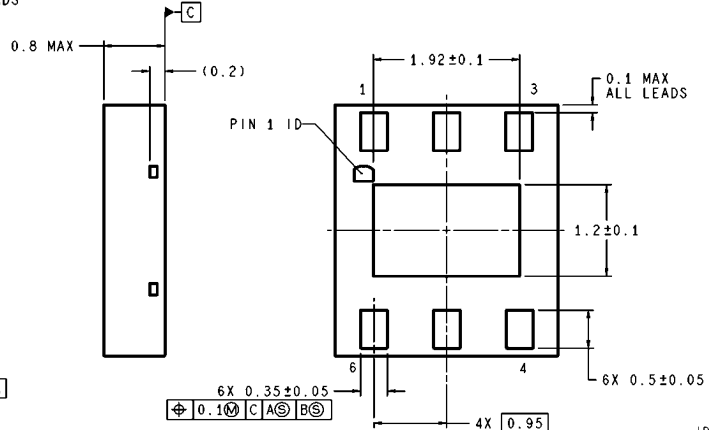
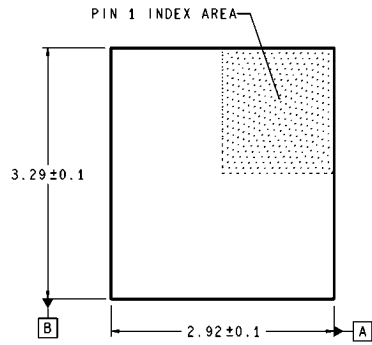

LLP, 6 Lead, Package (SOT23 Land)  
NS Package Number LDE06A

LDE06A (Rev A)

# Notes

LP3995

## Notes

For more National Semiconductor product information and proven design tools, visit the following Web sites at:

Products		Design Support	
Amplifiers	<a href="http://www.national.com/amplifiers">www.national.com/amplifiers</a>	WEBENCH	<a href="http://www.national.com/webench">www.national.com/webench</a>
Audio	<a href="http://www.national.com/audio">www.national.com/audio</a>	Analog University	<a href="http://www.national.com/AU">www.national.com/AU</a>
Clock Conditioners	<a href="http://www.national.com/timing">www.national.com/timing</a>	App Notes	<a href="http://www.national.com/appnotes">www.national.com/appnotes</a>
Data Converters	<a href="http://www.national.com/adc">www.national.com/adc</a>	Distributors	<a href="http://www.national.com/contacts">www.national.com/contacts</a>
Displays	<a href="http://www.national.com/displays">www.national.com/displays</a>	Green Compliance	<a href="http://www.national.com/quality/green">www.national.com/quality/green</a>
Ethernet	<a href="http://www.national.com/ethernet">www.national.com/ethernet</a>	Packaging	<a href="http://www.national.com/packaging">www.national.com/packaging</a>
Interface	<a href="http://www.national.com/interface">www.national.com/interface</a>	Quality and Reliability	<a href="http://www.national.com/quality">www.national.com/quality</a>
LVDS	<a href="http://www.national.com/lvds">www.national.com/lvds</a>	Reference Designs	<a href="http://www.national.com/refdesigns">www.national.com/refdesigns</a>
Power Management	<a href="http://www.national.com/power">www.national.com/power</a>	Feedback	<a href="http://www.national.com/feedback">www.national.com/feedback</a>
Switching Regulators	<a href="http://www.national.com/switchers">www.national.com/switchers</a>		
LDOs	<a href="http://www.national.com/lido">www.national.com/lido</a>		
LED Lighting	<a href="http://www.national.com/led">www.national.com/led</a>		
PowerWise	<a href="http://www.national.com/powerwise">www.national.com/powerwise</a>		
Serial Digital Interface (SDI)	<a href="http://www.national.com/sdi">www.national.com/sdi</a>		
Temperature Sensors	<a href="http://www.national.com/tempsensors">www.national.com/tempsensors</a>		
Wireless (PLL/VCO)	<a href="http://www.national.com/wireless">www.national.com/wireless</a>		

THE CONTENTS OF THIS DOCUMENT ARE PROVIDED IN CONNECTION WITH NATIONAL SEMICONDUCTOR CORPORATION ("NATIONAL") PRODUCTS. NATIONAL MAKES NO REPRESENTATIONS OR WARRANTIES WITH RESPECT TO THE ACCURACY OR COMPLETENESS OF THE CONTENTS OF THIS PUBLICATION AND RESERVES THE RIGHT TO MAKE CHANGES TO SPECIFICATIONS AND PRODUCT DESCRIPTIONS AT ANY TIME WITHOUT NOTICE. NO LICENSE, WHETHER EXPRESS, IMPLIED, ARISING BY ESTOPPEL OR OTHERWISE, TO ANY INTELLECTUAL PROPERTY RIGHTS IS GRANTED BY THIS DOCUMENT.

TESTING AND OTHER QUALITY CONTROLS ARE USED TO THE EXTENT NATIONAL DEEMS NECESSARY TO SUPPORT NATIONAL'S PRODUCT WARRANTY. EXCEPT WHERE MANDATED BY GOVERNMENT REQUIREMENTS, TESTING OF ALL PARAMETERS OF EACH PRODUCT IS NOT NECESSARILY PERFORMED. NATIONAL ASSUMES NO LIABILITY FOR APPLICATIONS ASSISTANCE OR BUYER PRODUCT DESIGN. BUYERS ARE RESPONSIBLE FOR THEIR PRODUCTS AND APPLICATIONS USING NATIONAL COMPONENTS. PRIOR TO USING OR DISTRIBUTING ANY PRODUCTS THAT INCLUDE NATIONAL COMPONENTS, BUYERS SHOULD PROVIDE ADEQUATE DESIGN, TESTING AND OPERATING SAFEGUARDS.

EXCEPT AS PROVIDED IN NATIONAL'S TERMS AND CONDITIONS OF SALE FOR SUCH PRODUCTS, NATIONAL ASSUMES NO LIABILITY WHATSOEVER, AND NATIONAL DISCLAIMS ANY EXPRESS OR IMPLIED WARRANTY RELATING TO THE SALE AND/OR USE OF NATIONAL PRODUCTS INCLUDING LIABILITY OR WARRANTIES RELATING TO FITNESS FOR A PARTICULAR PURPOSE, MERCHANTABILITY, OR INFRINGEMENT OF ANY PATENT, COPYRIGHT OR OTHER INTELLECTUAL PROPERTY RIGHT.

### LIFE SUPPORT POLICY

**NATIONAL'S PRODUCTS ARE NOT AUTHORIZED FOR USE AS CRITICAL COMPONENTS IN LIFE SUPPORT DEVICES OR SYSTEMS WITHOUT THE EXPRESS PRIOR WRITTEN APPROVAL OF THE CHIEF EXECUTIVE OFFICER AND GENERAL COUNSEL OF NATIONAL SEMICONDUCTOR CORPORATION.** As used herein:

Life support devices or systems are devices which (a) are intended for surgical implant into the body, or (b) support or sustain life and whose failure to perform when properly used in accordance with instructions for use provided in the labeling can be reasonably expected to result in a significant injury to the user. A critical component is any component in a life support device or system whose failure to perform can be reasonably expected to cause the failure of the life support device or system or to affect its safety or effectiveness.

National Semiconductor and the National Semiconductor logo are registered trademarks of National Semiconductor Corporation. All other brand or product names may be trademarks or registered trademarks of their respective holders.

Copyright© 2008 National Semiconductor Corporation

For the most current product information visit us at [www.national.com](http://www.national.com)



**National Semiconductor  
Americas Technical  
Support Center**  
Email:  
[new.feedback@nsc.com](mailto:new.feedback@nsc.com)  
Tel: 1-800-272-9959

**National Semiconductor Europe  
Technical Support Center**  
Email: [europe.support@nsc.com](mailto:europe.support@nsc.com)  
German Tel: +49 (0) 180 5010 771  
English Tel: +44 (0) 870 850 4288

**National Semiconductor Asia  
Pacific Technical Support Center**  
Email: [ap.support@nsc.com](mailto:ap.support@nsc.com)

**National Semiconductor Japan  
Technical Support Center**  
Email: [jpn.feedback@nsc.com](mailto:jpn.feedback@nsc.com)